

*HAUTE*

MUSEUM



# MUSEUM

UNIQUE SURFACES

**SUMMARY**  
**// RESUMEN**

Welcome to Haute:  
// Bienvenido a Haute:

**The Story // La historia**

page 4  
// pág. 4

**Graphics // Gráficas**

page 10  
// pág. 10

**Finishes and formats // Acabados y formatos**

page 22  
// pág. 22

**Combinations // Combinaciones**

page 30  
// pág. 30

**Technical information // Información técnica**

page 38  
// pág. 38



THE STORY

# HAUTE COUTURE IN CERAMIC TILES

---

# ALTA COSTURA HECHA CERÁMICA

LA HISTORIA



*HAUTE*

## **THE STORY // LA HISTORIA**

The term 'haute couture' is used to refer to bespoke fashion garments made of top-quality materials, handmade from start to finish by highly talented expert dressmakers with exquisite attention to detail.

Haute has all the makings of just such a collection, with a chic distinction worthy of Paris' most famous catwalks.

That is why Haute can be described as **haute couture in ceramic tiles.**

La alta costura es moda hecha a medida, de forma artesanal, con materiales de alta calidad. Su fabricación centra extrema atención al detalle, y es liderada por costureros con gran experiencia y talento.

Nuestra colección Haute cumple con todos los requisitos para convertirse en una colección exclusiva, que puede verse en las pasarelas más prestigiosas de París.

Por este motivo, **Haute es alta costura hecha cerámica.**





⊕ BM Haute White A/75,5x151/EP & BM Haute White B/75,5x151/EP

⊖ Haute White 75,5x151/EP

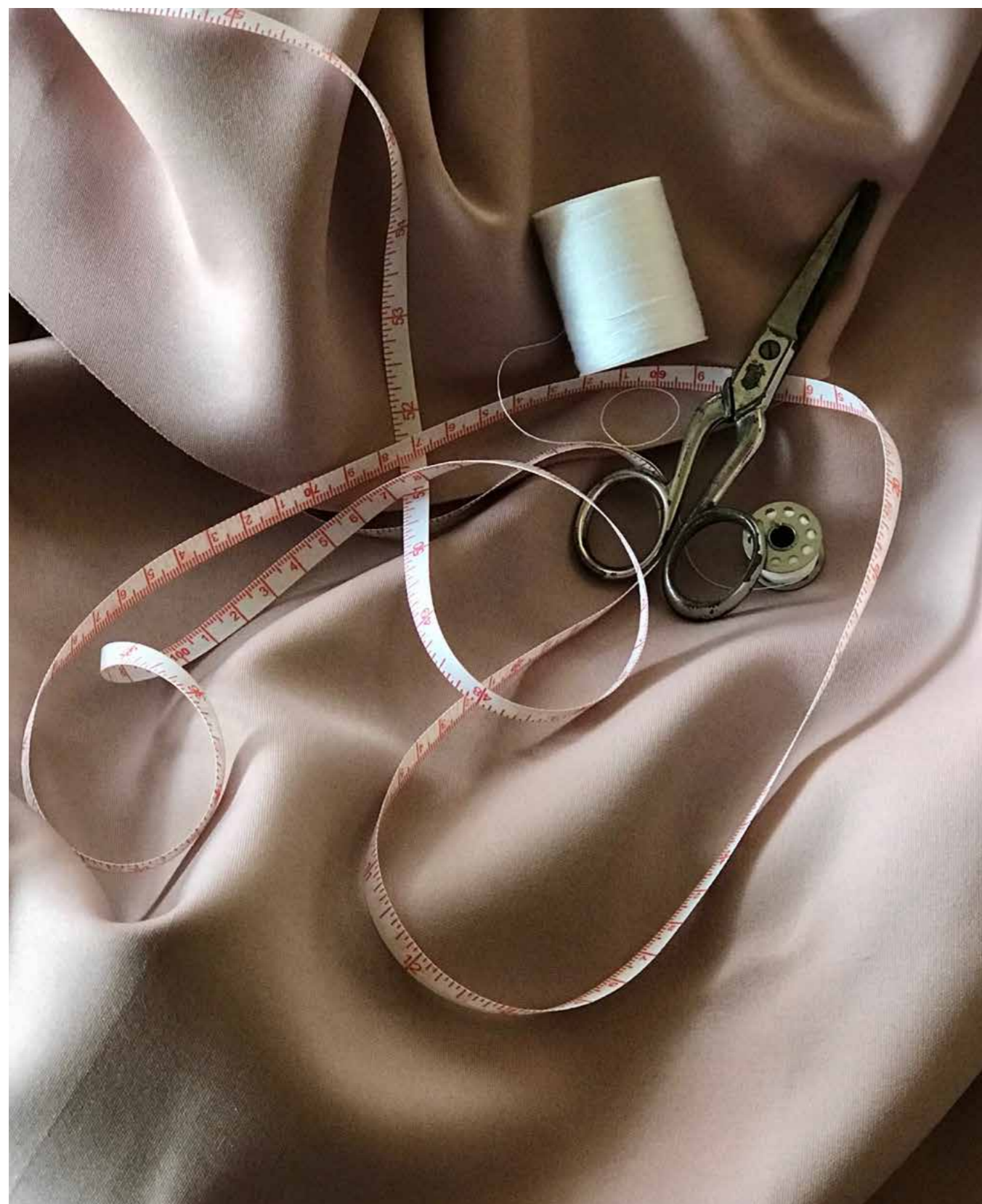

GRAPHICS

ONE DESIGN,  
ENDLESS POSSIBILITIES



UN DISEÑO,  
INFINITAS OPCIONES

GRÁFICAS





## GRAPHICS // GRÁFICAS

Haute is a collection inspired by well-known 'arabescato vagli' marble from northern Italy. It stands out for its dazzling white background, strewn with grey veins with the occasional sandy hue, all ensuring a chic stylish elegance.

Available in a Premium Polished, Polished or Shaped finish in a 100x180 cm, 100x100 cm, 75.5x151 cm or 60x120 cm format, the collection also features a complementary 75.5x151 cm Polished Book Match version and 33.3x100 cm micro-textured wall tiles in a Shaped finish.

La colección Haute se inspira en el conocido mármol 'arabescato vagli' que tiene su origen en el norte de Italia. Su gráfica se caracteriza por un fondo particularmente blanco, con veteado gris, y ciertos matices en tonalidad arena, que le confieren gran estilo y elegancia.

Disponibile in acabados Premium Polished, Polished y Shaped, y en formatos 100x180 cm, 100x100 cm, 75,5x151 cm y 60x120 cm. Además, se complementa con el Book Match en 75,5x151 cm Polished y el revestimiento 33,3x100 cm Shaped.

⊕ Haute White 100x180/P

⊖ Haute White 100x180/P





⊕ Haute White SP/100x180/R

⊖ Haute White SP/100x180/R



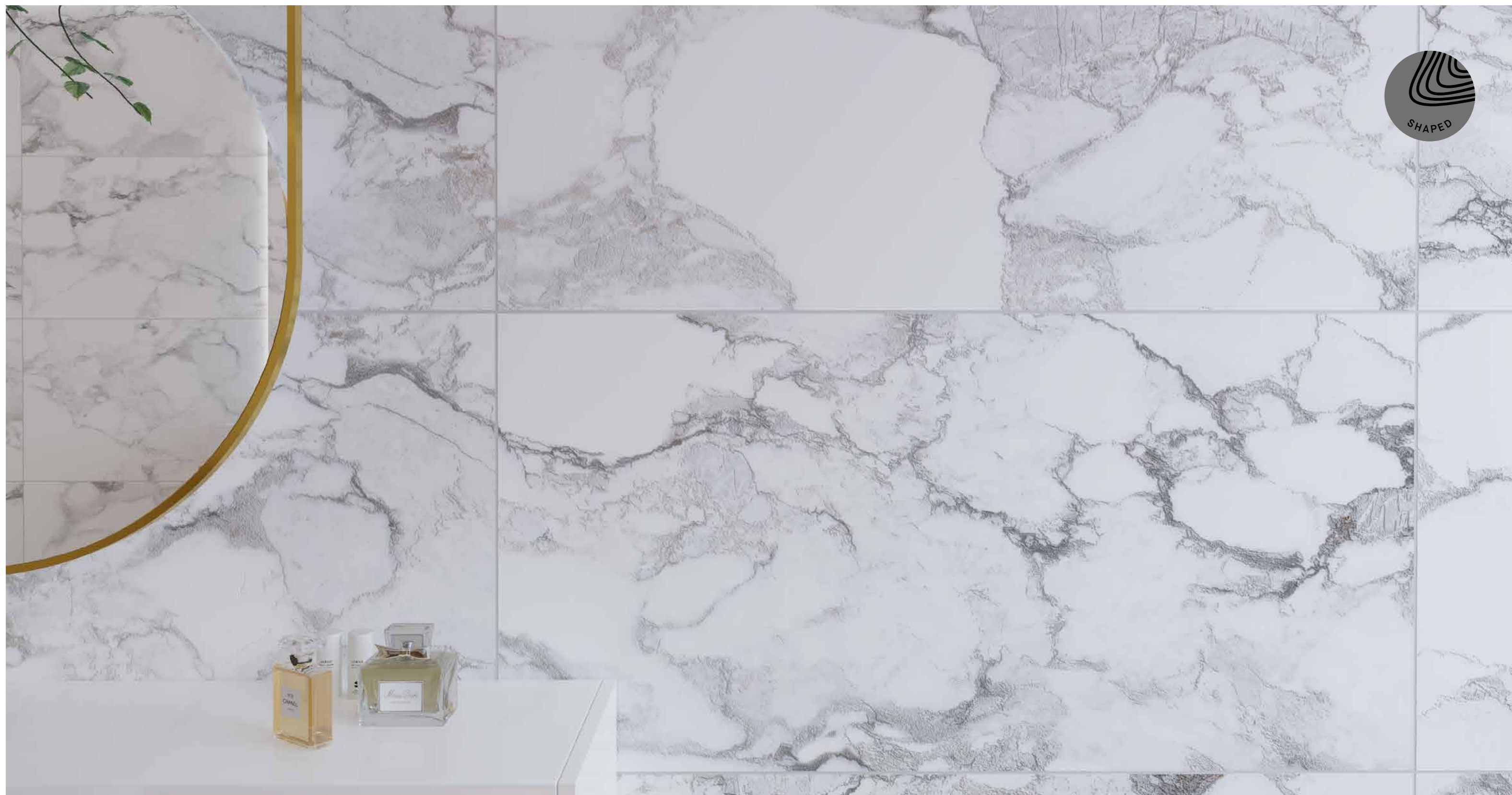

Haute White SP/60x120/R





⊕ Haute White SP/33,3x100/R & Haute White Decor SP/33,3x100/R

⊖ Haute White SP/100x100/R





*Fashion is not something  
that exists in dresses only.*

- Coco Chanel

*La moda no es algo que  
sólo exista en los vestidos.*

- Coco Chanel







FINISHES & FORMATS

# MASTERLY TAILORING

---

# NUESTRA PUNTADA MAESTRA

ACABADOS Y FORMATOS

**FINISHES**  
**// ACABADOS**

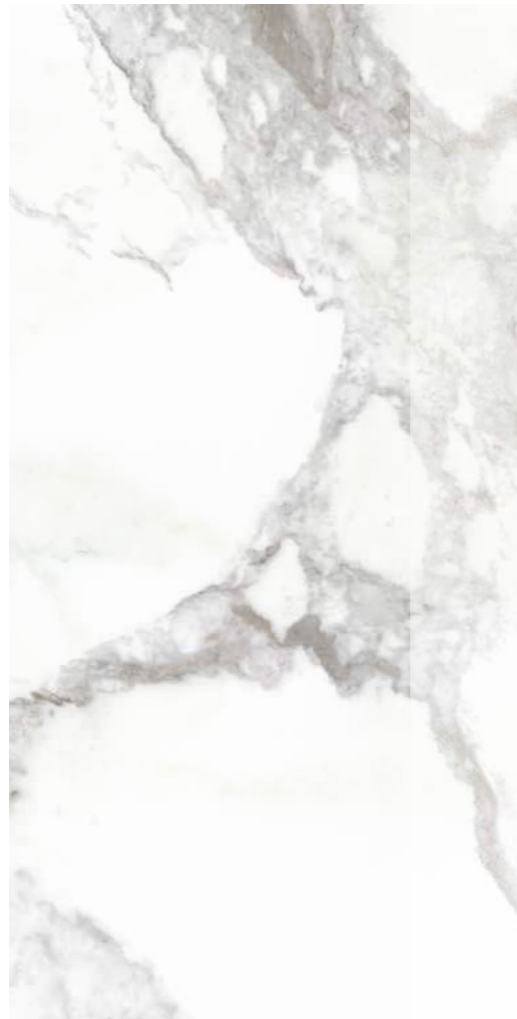

**PREMIUM POLISHED**

Polished crystal mirror finish  
with a perfect reflection.

Available in 4D TECH.

**PULIDO PREMIUM**

Acabado pulido con un perfecto  
reflejo especular.

Disponible en 4D TECH.



**POLISHED**

Polished smooth finish with  
deep reflection.

**PULIDO**

Acabado liso pulido con  
reflejo profundo.





## SHAPED

Smooth texture, the graphic is perfectly coordinated with the relief.

## SHAPED

Textura suave, la gráfica se coordina perfectamente con el relieve.



**FORMATS**  
**// FORMATOS**

100 x 180 cm



100 x 100 cm

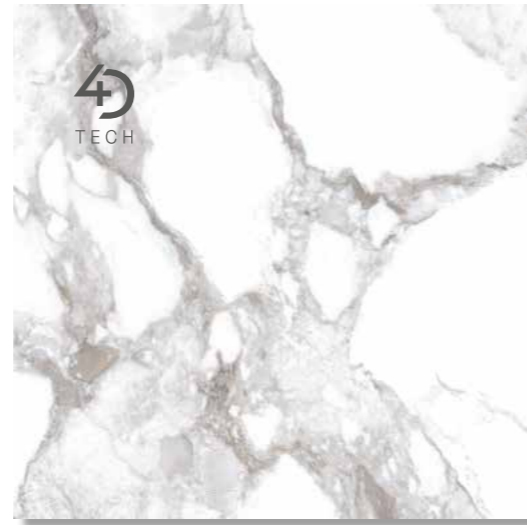

**Finishes // Acabados**



**Thickness // Espesor**  
*8 mm*

**Finishes // Acabados**



**Thickness // Espesor**  
*8 mm*

75,5 x 151 cm



**Finishes // Acabados**

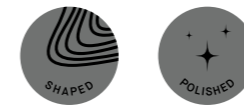

**Thickness // Espesor**  
*10 mm*

60 x 120 cm

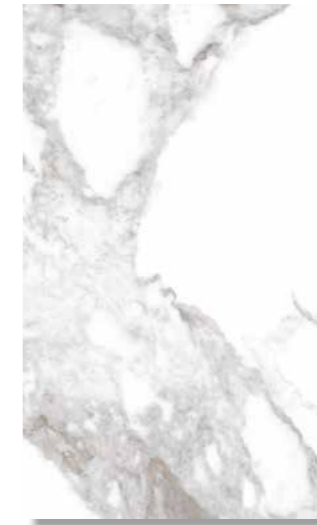

**Finishes // Acabados**

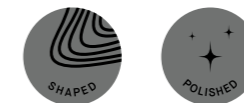

**Thickness // Espesor**  
*10 mm*

33,3 x 100 cm



**Finishes // Acabados** *white body*



**Thickness // Espesor**  
*10,5 mm*





① D. Haute White/Taupe Chevron SP/30x21,9

COMBINATIONS

MIX AND MATCH



MEZCLA Y COMBINA

COMBINACIONES



## COMBINATIONS // COMBINACIONES

A seed in the earth marks the beginning of a tree's life. During the initial days of its life, this seed uses the energy inside it to activate the growth of its first roots. These roots then start to absorb any surrounding energy in order to fuel their own growth.

MUSEUM also has a history. It too was born of a seed, and technologies and innovation are the driving forces that fuel its continual growth.

This new collection embodies this process in **a new offshoot that still remains true to our roots.**

Una semilla en la tierra marca el principio de la vida de un árbol. Durante los primeros días de vida, esta semilla usa la energía que guarda en su interior para activar el crecimiento de sus primeras raíces. A partir de entonces, la raíz comienza a absorber energía de su alrededor para producir la suya propia y, con ella, crecer.

MUSEUM también tiene una historia, también nació de una semilla y la utilización de las tecnologías y la innovación son las fuentes de energía que hacen que la marca crezca diariamente.

Esta nueva colección hace tangible todo este proceso, formando **una nueva rama, pero siempre teniendo claro dónde están nuestras raíces.**

# Meet Grow // Conoce Grow

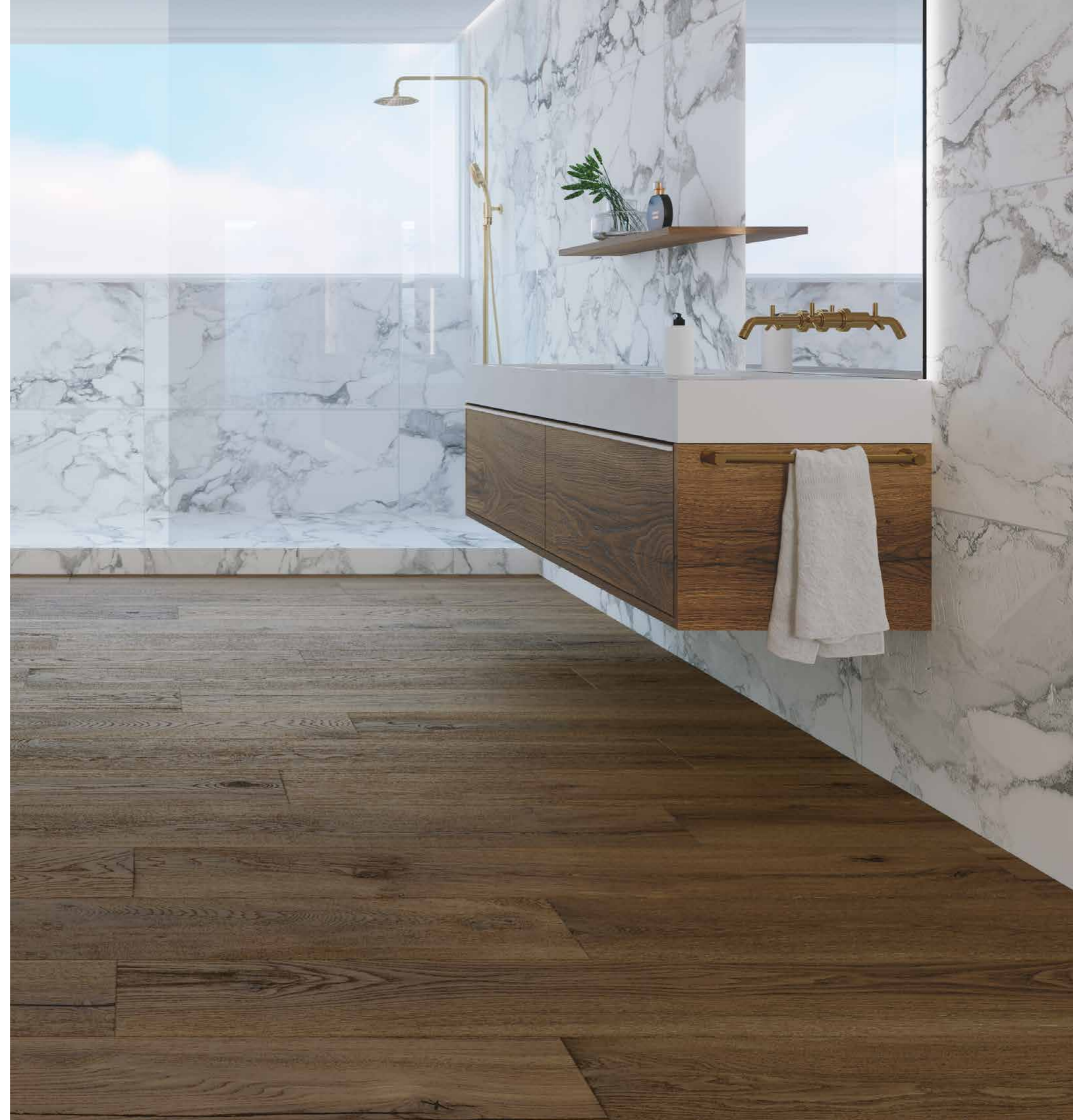



## COMBINATIONS // COMBINACIONES

High-performance sports encompass activities as wide ranging as swimming, fencing, gymnastics and even chess. Nonetheless, all top sportsmen and women share one characteristic: perseverance—that is, falling but getting back on your feet again, striving to improve, and managing to overcome major challenges.

What drives top sportsmen and women to excel is the constant desire to perfect each and every one of their moves. According to many of them, it is not a question of competing against other people but of competing against themselves.

Elite is a collection aimed at all those who refuse to toe the line, all those who think big, and all those who seek to break their own record.

With Elite, we pay tribute to our **strongest, most indomitable facet.**

El deporte de élite existe en disciplinas tan diversas como la natación, la esgrima, la gimnasia deportiva e incluso el ajedrez. Pero todos los mejores deportistas tienen un rasgo en común: la perseverancia. Caer y levantarse, seguir mejorando a cada paso y superar los mayores retos.

La constante búsqueda de la perfección en cada movimiento es lo que empuja al deportista de élite a cruzar sus límites. Según muchos de ellos, la competición no es entre personas, la lucha es interna.

Una colección pensada para todos aquellos que no se conforman, que piensan en grande, que quieren batir su propio récord. Con Elite sacamos a relucir **nuestro lado más fuerte, más imbatible.**

# Meet Elite // Conoce Elite





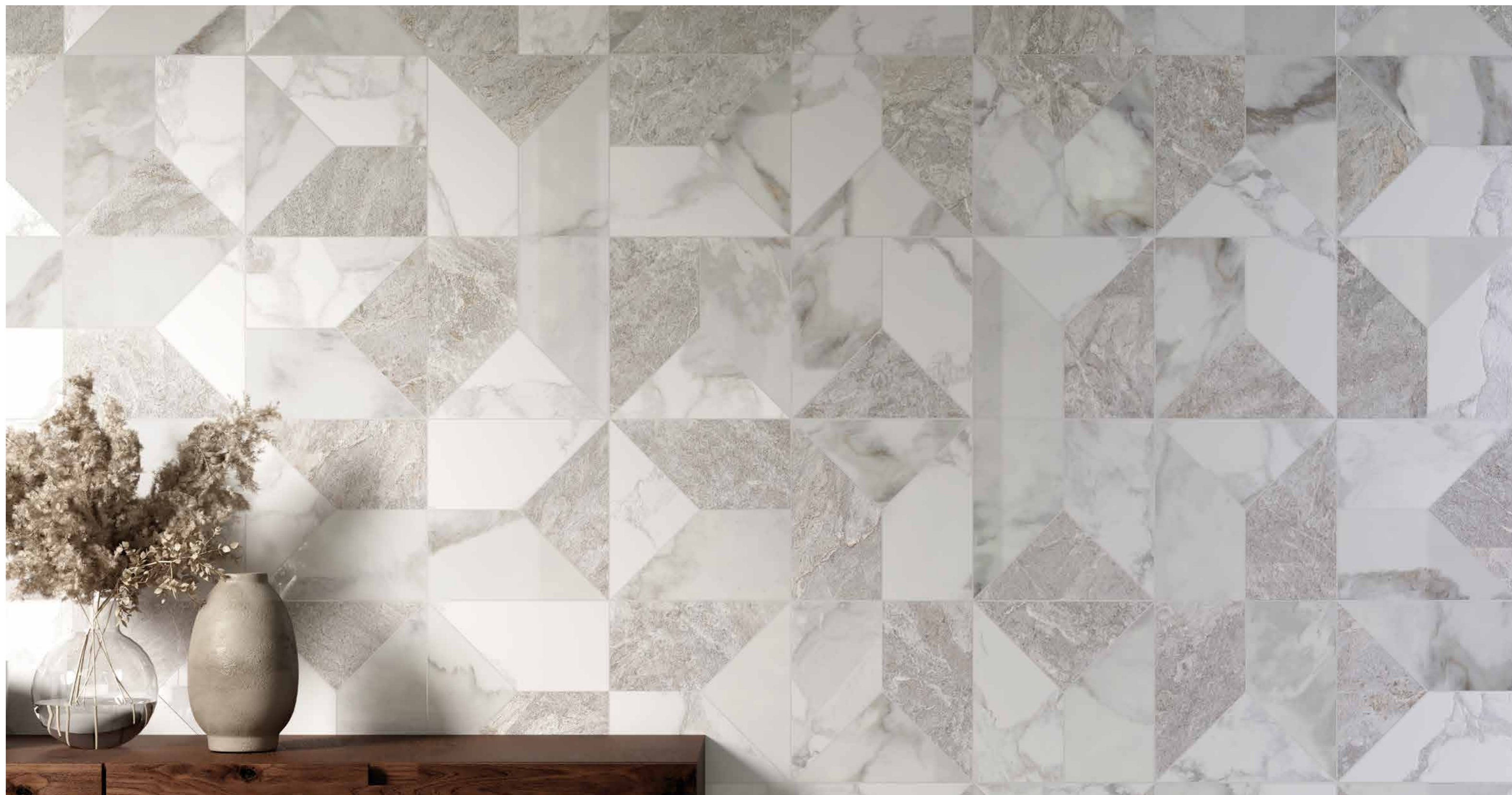

Ⓜ D. Haute White/Dolphin Mix/30x30





TECHNICAL INFORMATION

# TECHNIQUES OF OUR HIGH SEWING

---

# TÉCNICAS DE NUESTRA ALTA COSTURA

INFORMACIÓN TÉCNICA

**TECHNICAL INFORMATION**  
// **INFORMACIÓN TÉCNICA**

**FINISHES // ACABADOS**

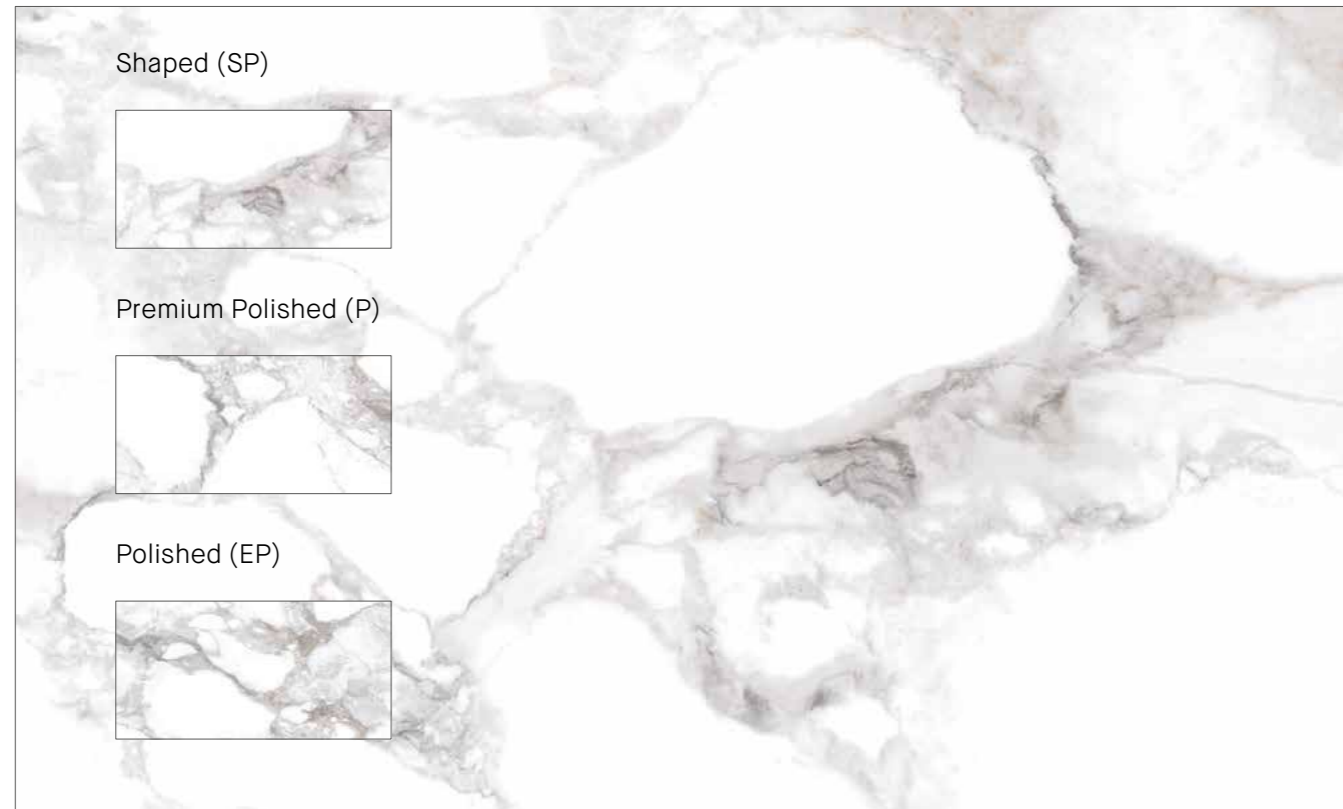

**COLOURS // COLORES**



White

Porcelain

White body

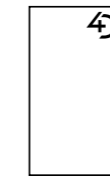

100x180 cm  
39,4x70,8 "

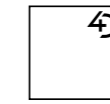

100x100 cm  
39,4x39,4 "



75,5x151 cm  
29,7x59,4 "



60x120 cm  
23,6x47,2 "

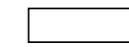

33,3x100 cm  
13,1x39,4 "



33,3x100 cm  
13,1x39,4 "

	8 mm		10 mm		10,5 mm			
	Patterns	12	12	16	25	24	24	
Shade Variation	V2		V2		V2		V2	
	Shaped (SP)	31006 M94	31007 M93	31005 M103	31001 M101	31051 M96	31052 M97	
	Premium Polished (P)	31209 M76	-	-	-	-	-	
	Polished (EP)	-	-	31000 M58	30996 M40	-	-	

\* Coordinated installation: make sure the textured face is looking downwards.  
\* Colocación entre piezas: recomendable colocar la textura hacia abajo.

Book Match

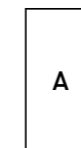

75,5x151 cm  
29,7x59,4 "

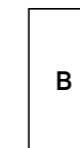

75,5x151 cm  
29,7x59,4 "

	10 mm	10 mm
Thickness	10 mm	10 mm
Patterns	1	1
Shade Variation	V2	
Polished (EP)	31029 M35	31030 M35

Option 1

Option 2

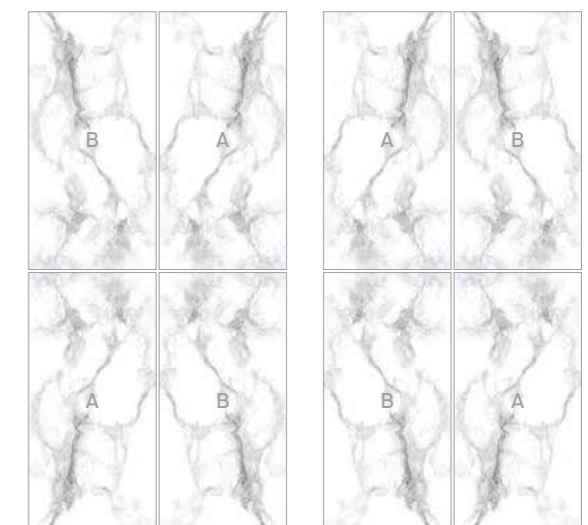



**TECHNICAL INFORMATION**  
**// INFORMACIÓN TÉCNICA**

**SPECIAL PIECES // PIEZAS ESPECIALES**

Porcelain (10 mm)

TRAP.

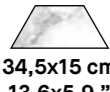
	WHITE	Shaped (SP)	<b>31146</b> U34
34,5x15 cm 13,6x5,9 "			
	WHITE	Polished (EP)	<b>31147</b> U34
34,5x15 cm 13,6x5,9 "			

Porcelain (10 mm)

D. MIX

	WHITE & WHITE & Elite Dolphin	Shaped (SP) & Polished (EP) & Shaped (SP)	<b>31148</b> U51
30x30 cm 11,8x11,8 "			



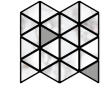

White body (10,5 mm)

D. TRIANGLE \*

	WHITE	Shaped (SP)	<b>31149</b> U55
29x29 cm 11,4x11,4 "			

Porcelain (10 mm)

D. CHEVRON



	WHITE & Grow Kalua	Shaped (SP) & Shaped (SP)	<b>31155</b> U51
30x21,9 cm 11,8x8,6 "			
	WHITE & Grow Kalua	Polished (EP) & Shaped (SP)	<b>31152</b> U51
30x21,9 cm 11,8x8,6 "			
	WHITE & Grow Taupe	Shaped (SP) & Shaped (SP)	<b>31154</b> U51
30x21,9 cm 11,8x8,6 "			
	WHITE & Grow Taupe	Polished (EP) & Shaped (SP)	<b>31151</b> U51
30x21,9 cm 11,8x8,6 "			

\* Only suitable for wall installations.  
\* Adecuado únicamente como revestimiento.

**TECHNICAL DATA // DATOS TÉCNICOS**

FINISHES	DIN 51130	DIN 51097	UNE-ENV 126 33	BS 7976-2 (PTV)	ANSI A137.1 (DCOF)
Shaped (SP) 10 mm	R10	A + B	Class 2	+36 Wet	>0,42 Wet
Shaped (SP) 8 mm	-	-	Class 1	-	>0,42 Wet

**COMPLEMENTARY PIECES // PIEZAS COMPLEMENTARIAS**

S.K.I.	S.K.D.	SKIRTING			
	8x30 cm 3,1x11,8 "		8x100 cm 3,1x39,4 "	8x75,5 cm 3,1x29,7 "	8x60 cm 3,1x23,6 "
Shaped (SP) 8 mm	U53	Shaped (SP) 8 mm	U45	-	-
Premium Polished (P)	U53	Premium Polished (P)	U48	-	-
Shaped (SP) 10 mm	U53	Shaped (SP) 10 mm	-	U43	U35
Polished (EP)	U53	Polished (EP)	-	U43	U35

TECHNICAL STAIR TREAD

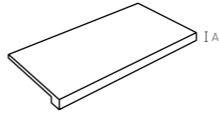
	30x180 cm 11,8x39,4 "	30x151 cm 11,8x59,4 "	30x120 cm 11,8x47,2 "	30x100 cm 11,8x39,4 "	30x75,5 cm 11,8x29,7 "	30x60 cm 11,8x23,6 "
Shaped (SP) 8 mm	U90	-	-	U74	-	-
Premium Polished (P)	U90	-	-	U74	-	-
Shaped (SP) 10 mm	-	U86	U75	-	U76	U54
Polished (EP)	-	U86	U75	-	U76	U54

\* When thickness is 8 mm, A = 24 mm; when 10 mm, then A = 30 mm.  
\* Cuando el espesor es 8 mm, A = 24 mm; cuando es 10 mm, entonces A = 30 mm.

**PACKING // PACKING**

SIZE // FORMATO	BOX // CAJA			PALLET			CONTAINER 20' (24000 Kg.)			
	Piezas	m <sup>2</sup>	kg	Cajas	m <sup>2</sup>	kg	largo x alto x ancho	N° pallets	m <sup>2</sup>	kg
100 x 180 x 0,8	2	3,6	70,25	18	64,8	1315	190 x 115 x 60	17	1101,6	22347
75,5 x 151 x 1	1	1,14	26	44	50,16	1189	160 x 92 x 76	17	852,72	20213
60 x 120 x 1	2	1,44	33,18	27	38,88	921	120 x 80 x 75	26	1010,8	23942
100 x 100 x 0,8	2	2	36,8	32	64	1220	112 x 112 x 100	19	1216	23172
33,3 x 100 x 1,05	4	1,33	24	48	63,84	1177	118 x 110 x 81	20	1276,8	23540
<b>inch</b>	<b>Units</b>	<b>ft<sup>2</sup></b>	<b>lb</b>	<b>Boxes</b>	<b>ft<sup>2</sup></b>	<b>lb</b>	<b>length x width x height</b>	<b>N° pallets</b>	<b>ft<sup>2</sup></b>	<b>lb</b>
39,4 x 70,8 x 0,35	2	38,75	154,87	18	775	3208	71,2 x 44,1 x 25,2	17	12400,12	51323
29,7 x 59,4 x 0,39	1	12,27	37,68	44	539,92	2621	62,9 x 36,2 x 29,9	17	9178,6	44562
23,6 x 47,2 x 0,39	2	15,5	82,95	27	418,5	2030	47,2 x 31,4 x 29,5	26	10881	52783
39,4 x 39,4 x 0,35	2	21,53	81,12	32	688,89	2689	44,1 x 44,1 x 39,4	19	13088,92	51086
13,11 x 39,4 x 0,41	4	14,31	52,91	48	687,16	2595	46,4 x 43,3 x 31,8	20	13743,47	51897

# MUSEUM

Once ceramic tiles reach the end of their useful life, they are inert waste. For their proper management, they should be given to an authorized waste management body for recycling purposes.

All colours and hues appearing in this catalogue should be considered approximate, only in view of the printing processes involved. The rights of all contents (texts, photographs, drawings, designs, etc.) of this catalogue remain the property of PERONDA GROUP S.A (or, failing that, they have the corresponding permissions of the owners). No part of this publication may be reproduced, stored in a retrieval system, or transmitted in any form or by any means, electronic, mechanical, photocopying, recording or otherwise, without the prior written permission of the copyright holders.

© PERONDA GROUP 2021

Las baldosas cerámicas una vez que llegan al final de su vida útil son un residuo inerte, que para su correcta gestión debe ser entregado a un gestor autorizado de residuos, favoreciendo su reciclado.

Debido a los procesos de impresión, los colores que aparecen en este catálogo deben considerarse aproximados, y no exactos. Los derechos de todos los contenidos (textos, fotografías, dibujos, diseños etc) del presente catálogo son propiedad de PERONDA GROUP, S.A (o en su defecto, cuentan con los correspondientes permisos y autorizaciones de sus titulares). No está permitida la reproducción total o parcial de esta publicación, ni su tratamiento informático, ni la transmisión de ninguna forma o por cualquier medio, ya sea electrónico, mecánico, por fotocopia, por registro u otros medios, sin el permiso previo y por escrito de los titulares del copyright.

Av. Manuel Escobedo, 26  
12200 Onda (Castellón) Spain  
+34 964 602 012



